

Fitting for top-running wooden doors up to 60 kg (132 lbs.), with surface mounted running track. Optionally with soft and self closing mechanism. Wall or ceiling mounting.

Product highlights

- Flexibility** Ceiling mounting with customer-provided panelling or integrated clip-on panel in aluminium or wood
- Productivity** Retrofitting of all components through the provided assembly opening, prevents contamination during construction work

Technical specifications

- Max. 60 kg (132 lbs.)
- Max. 2700 mm (8'10 5/16")
- Max. 1600 mm (5'3")
- 30–80 mm (1 3/16" to 3 5/32")

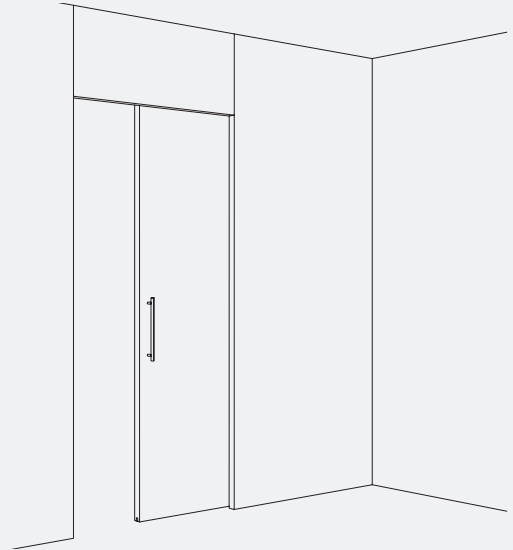



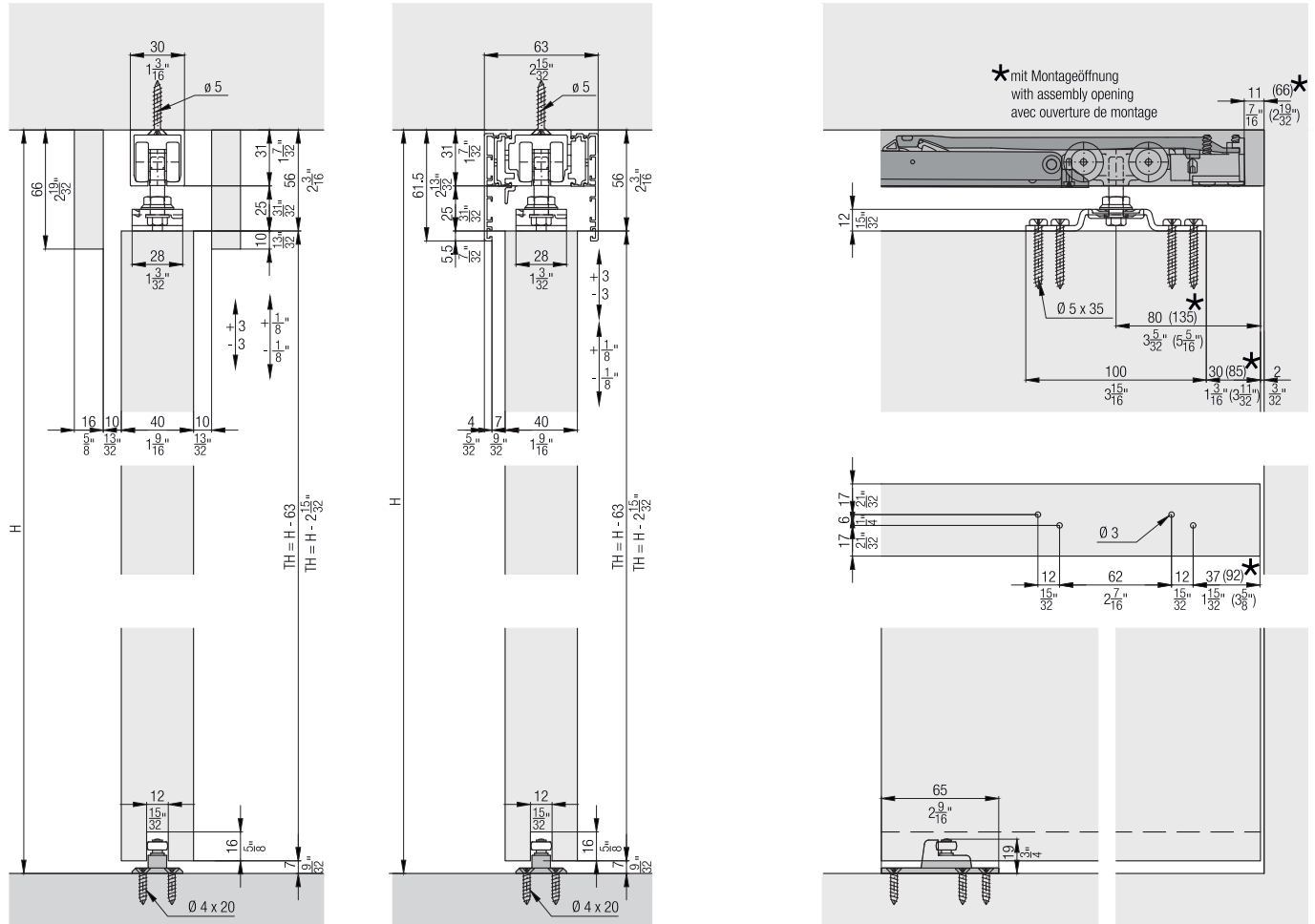



Installation examples











**Set for ceiling or wall mounting,
for 1 wooden door up to 60 kg (132 lbs.)**

	No.
Hawa Porta 60 H/HC, for 1 door	057.3138.071
Hawa Porta 60 H/HC, black, for 1 door	057.3138.075





Set consisting of:	057.3138.071		057.3138.075		No.
 Running gear, plain bearings, rollers plastic blue	2	2			057.3115.071
 Stopper, with retention spring, plastic, gray	2				057.3073.072
 Suspension bolt, M8x32 mm (5/16"x1 1/4"), steel, zinc-plated	2	2			057.0123.104
 Hexagon locking nut, M8, steel, zinc-plated	2	2			768.9005.101
 Support bracket, height and lateral adjustable, steel, zinc-plated	2	2			057.3129.101
 Pan head screw, 5x35 mm (3/16"x1 3/8"), steel, zinc-plated	8	8			766.6051.135
 Bottom guide, with roller, adjustable, plastic, anthracite	1	1			057.3120.071
 Countersunk head screw, 4x20 mm (5/32"x25/32"), steel, zinc-plated	4				766.5042.120
 Stopper, with retention spring, plastic, black		2			057.3073.076
 Countersunk head screw, 4x20 mm, steel, zinc-plated		4			600.0000.817

**Set for ceiling or wall mounting,
for 1 wooden door up to 60 kg (132 lbs.)**

	No.
Hawa Porta 60 H, with running track, 2000 mm (6' 6 3/4"), aluminum, for 1 door	057.3140.071



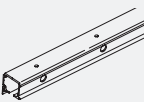

Set consisting of:	057.3140.071		No.
	mm (inch)		
 Running gear, plain bearings, rollers plastic blue		2	057.3115.071
 Stopper, with retention spring, plastic, gray		2	057.3073.072
 Suspension bolt, M8x32 mm (5/16"x1 1/4"), steel, zinc-plated		2	057.0123.104
 Hexagon locking nut, M8, steel, zinc-plated		2	768.9005.101
 Support bracket, height and lateral adjustable, steel, zinc-plated		2	057.3129.101
 Pan head screw, 5x35 mm (3/16"x1 3/8"), steel, zinc-plated		8	766.6051.135
 Bottom guide, with roller, adjustable, plastic, anthracite		1	057.3120.071
 Countersunk head screw, 4x20 mm (5/32"x25/32"), steel, zinc-plated		4	766.5042.120
 Running track, aluminum, pre-drilled	2,000 (6' 6 3/4")	1	057.3016.200

Running tracks

		mm (inch)	No.
	Running track, aluminum, pre-drilled	1,700 (5' 6 15/16")	057.3016.170
		2,000 (6' 6 3/4 ")	057.3016.200
		2,500 (8' 2 7/16")	057.3016.250
		6,000 (19' 8 7/32")	057.3016.600
		cut to size	057.3016.990
	Running track, aluminum, anodized, pre-drilled	2,000 (6' 6 3/4 ")	057.3016.201
		2,500 (8' 2 7/16")	057.3016.251
		6,000 (19' 8 7/32")	057.3016.601
		cut to size	057.3016.991
	Running track, with assembly opening, aluminum, anodized, pre-drilled	2,500 (8' 2 7/16")	057.3016.256
		cut to size	057.3016.998
	Combi running track, aluminum, pre-drilled	1,700 (5' 6 15/16")	057.3048.170
		2,000 (6' 6 3/4 ")	057.3048.200
		2,500 (8' 2 7/16")	057.3048.250
		3,500 (11' 5 25/32")	057.3048.350
		6,000 (19' 8 7/32")	057.3048.600
	cut to size	057.3048.990	
	Combi running track, aluminum, black anodized, pre-drilled	2,500 (8' 2 7/16")	057.3048.255
		3,500 (11' 5 25/32")	057.3048.355
cut to size		057.3048.990	
	Disposable cover to running track Hawa Porta 45/60/100, plastic, black	2,000 (6' 6 3/4 ")	057.3098.001
		cut to size	057.3098.990

Assembly set

		No.
Assembly set Hawa Porta 60/100, 2000 mm (6' 6 3/4")		057.3179.200
Assembly set Hawa Porta 60/100, 2500 mm (8' 2 7/16")		057.3179.250

		mm (inch)	057.3179.200	057.3179.250	No.
Set consisting of:					
	Running track, aluminum, anodized, pre-drilled	2,000 (6' 6 3/4 ")	1		057.3174.200
	Assembly pin, plastic, gray		9	11	057.0201.001
	Countersunk head screw, 5x40 mm (3/16"x1 9/16"), steel, zinc-plated		10	12	766.3054.140
	Running track, aluminum, anodized, pre-drilled	2,500 (8' 2 7/16")		1	057.3174.250

Panels

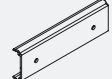

		mm (inch)	No.	
	Clip-on panel, aluminum, anodized	2,500 (8' 2 7/16")	042.3004.250	
		3,500 (11' 5 25/32")	042.3004.350	
		6,000 (19' 8 7/32")	042.3004.600	
		cut to size	042.3004.990	
		Clip-on panel, aluminum, black anodized	2,500 (8' 2 7/16")	042.3004.255
	3,500 (11' 5 25/32")	042.3004.355		

Clip-on components

		No.
	Clip component for wooden and aluminum panel, every 500 mm (1'7 11/16"), aluminium, pre-drilled	057.3117.001
	Clip component for wooden and aluminum panel, every 500 mm (1'7 11/16"), aluminium, black anodized, pre-drilled	057.3117.005

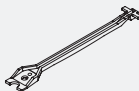

Soft close
**For soft closing in opening and closing direction
order 2 sets.**

	No.
Soft close Hawa Porta 60/100, Divido 100, 10–60 kg (22–132 lbs.), 1 piece	042.3102.072

		042.3102.072	No.
Set consisting of:			
	Soft close, top running, 10–60 kg (22 to 132 lbs.), plastic	1	042.3106.072
	Trigger for soft close in buildings, zinc die casting	1	042.3105.001
	Screw set soft close	1	600.0000.566

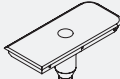

Cover for assembly opening

	No.
Cover cap to assembly opening, 1-piece set	042.3114.071

		042.3114.071	No.
Set consisting of:			
	Cover cap assembly opening, plastic, gray	1	042.0172.001
	Screw set soft close	1	600.0000.566

Bracket set for wall mounting



	No.
Angle bracket for wall mounting, steel, zinc-plated, 10-piece set	057.3005.172

		057.3005.172	No.
Set consisting of:			
	Wall mounting angle bracket, steel, zinc-plated	10	057.0169.101
	Countersunk head screw, M5x12 mm (3/16"x15/32"), steel, zinc-plated	10	762.5008.100
	Hexagon nut, M5, steel, zinc-plated	10	768.9025.100

Bottom guide set for wall mounting

	No.	
	Set bottom guide for wall mounting, with roller	057.3128.171

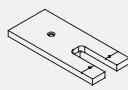
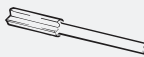
Accessories

	No.	
	Routing jig for assembly opening	042.3118.071
	Groove cutter to routing jig, Ø= 10 mm (13/32"), hard metal	600.0000.309
	Track cleaner, plastic, blue	057.3099.071

Assembly set/Wooden panel

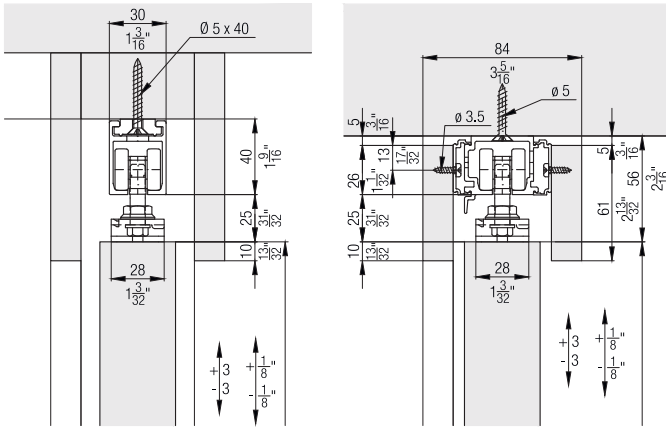

Optional: Wall mounting

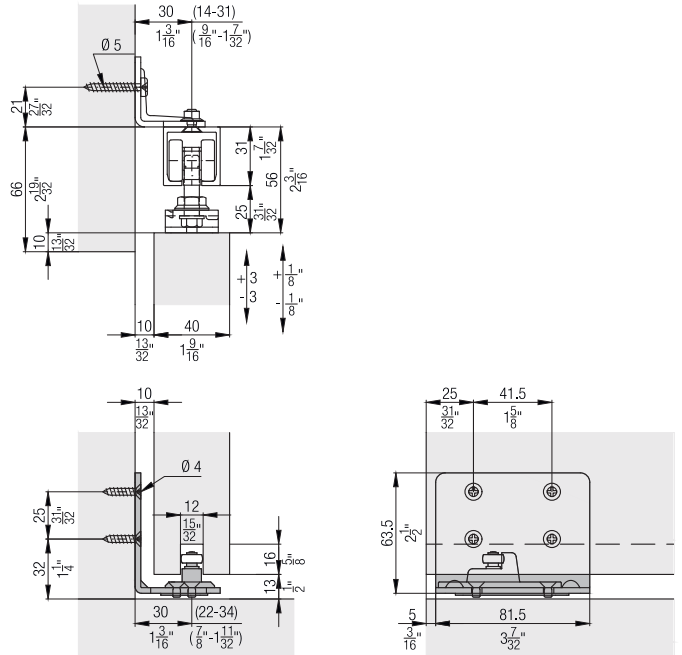

Soft close

	Z =					
	0		1		2	
Hawa Porta 60/100 H/HC	1' 6 29/32"	1' 9 1/16"	1' 11 1/4"	2' 4 3/4"	2' 6 23/32"	2' 9 3/32"
Hawa Porta 60/100 HM/HMD/HMT	1' 6 29/32"	1' 9 1/16"	1' 11 1/4"	2' 4 3/4"	2' 6 23/32"	2' 9 3/32"
Hawa Porta 100 G/GU/GM	1' 6 29/32"	1' 9 1/16"	1' 11 1/4"	2' 4 3/4"	2' 6 23/32"	2' 9 3/32"
Hawa Porta 100 GW/GWF	1' 8 5/32"	1' 9 11/32"	1' 11 1/4"	2' 6"	2' 6 29/32"	2' 7 3/16"
Hawa Porta 100 GMD	1' 7 7/32"	1' 9 7/32"	1' 11 1/4"	2' 5 1/16"	2' 7 1/16"	2' 7 3/16"
Hawa Divido 100 H/HM/GR	1' 6 29/32"	1' 9 1/16"	1' 11 1/4"	2' 4 3/4"	2' 6 23/32"	2' 9 3/32"
Hawa Divido 100 GRM	1' 8 5/32"	1' 10 11/32"	1' 0 1/2"	2' 6"	2' 8 5/32"	2' 10 11/32"

	Z =					
	0		1		2	
Hawa Porta 60/100 H/HC	480	535	590	730	785	840
Hawa Porta 60/100 HM/HMD/HMT	480	535	590	730	785	840
Hawa Porta 100 G/GU/GM	480	535	590	730	785	840
Hawa Porta 100 GW/GWF	512	542	590	762	792	840
Hawa Porta 100 GMD	488	539	590	738	789	840
Hawa Divido 100 H/HM/GR	480	535	590	730	785	840
Hawa Divido 100 GRM	512	567	622	762	817	872

Accessories

- Lock solutions from page 374
- General accessories from page 383

Planning/execution

Further information about the product can be found on www.hawa.com.